

Time Code Receiver

Description

The U4224B is a bipolar integrated straight through receiver circuit in the frequency range of 40 to 80 kHz. The device is designed for radio controlled clock applications.

Features

- Very low power consumption
- Very high sensitivity
- High selectivity by using two crystal filters
- Power down mode available
- Only a few external components necessary
- Digitalized serial output signal
- AGC hold mode

Block Diagram

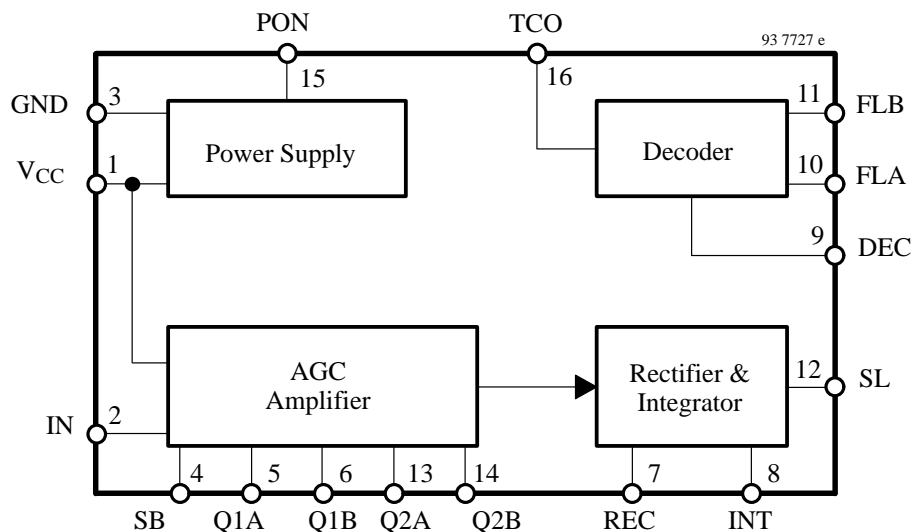

Pin Description

Pin	Symbol	Function
SO 16 L		
1	V _{CC}	Supply voltage
2	IN	Amplifier – Input
3	GND	Ground
4	SB	Bandwidth control
5	Q1A	Crystal filter 1
6	Q1B	Crystal filter 1
7	REC	Rectifier output
8	INT	Integrator output
9	DEC	Decoder input
10	FLA	Low pass filter
11	FLB	Low pass filter
12	SL	AGC hold mode
13	Q2A	Crystal filter 2
14	Q2B	Crystal filter 2
15	PON	Power ON/OFF control
16	TCO	Time code output

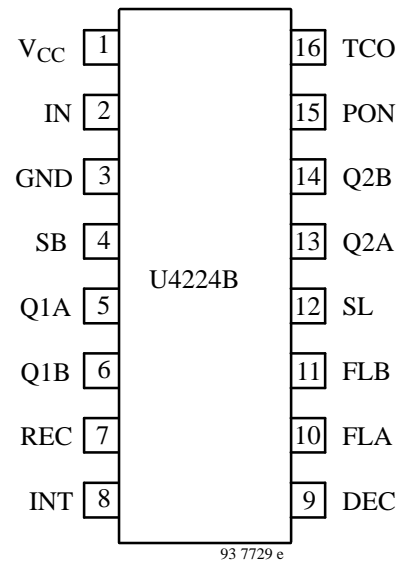

IN

A ferrite antenna is connected between IN and V_{CC}. For high sensitivity the Q of the antenna circuit should be as high as possible, but a high Q often requires temperature compensation of the resonant frequency. Specifications are valid for Q > 30. An optimal signal to noise ratio will be achieved by a resonant resistance of 50 to 200 kΩ.

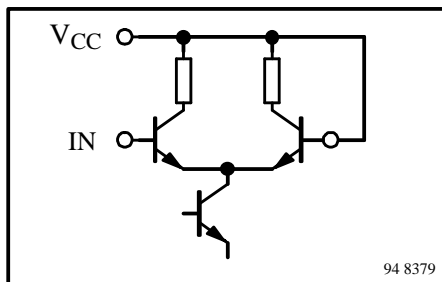

SB

A resistor R_{SB} is connected between SB and GND. It controls the bandwidth of the crystal filters. It is recommended: R_{SB} = 0 Ω for DCF 77.5 kHz, R_{SB} = 10 kΩ for 60 kHz WWVB and R_{SB} = open for JG2AS 40 kHz.

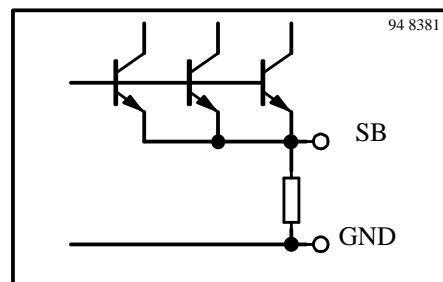

Q1A, Q1B

In order to achieve a high selectivity, a crystal is connected between the pins Q1A and Q1B. It is used with the serial resonance frequency of the time code transmitter (e.g. 60 kHz WWVB, 77.5 kHz DCF or 40kHz JG2AS).

The equivalent parallel capacitor of the filter crystal is internally compensated. The compensated value is about 0.7 pF. If the full sensitivity and selectivity is not needed, the crystal filter can be substituted by a capacitor of 10 pF for DCF and WWVB and 22 pF for JG2AS.

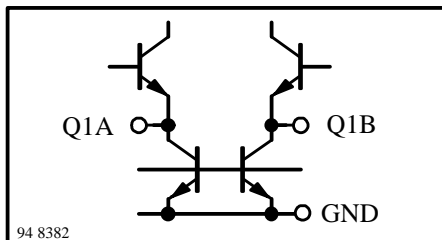

SL

AGC hold mode: SL high ($V_{SL} = V_{CC}$) sets normal function, SL low ($V_{SL} = 0$) disconnects the rectifier and holds the voltage V_{INT} at the integrator output and also the AGC amplifier gain.

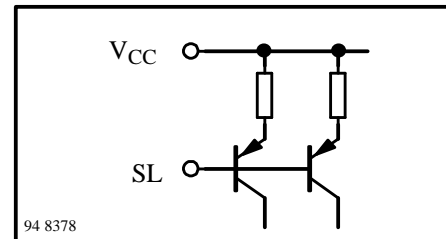

REC

Rectifier output and integrator input: The capacitor C1 between REC and INT is the lowpass filter of the rectifier and at the same time a damping element of the gain control.

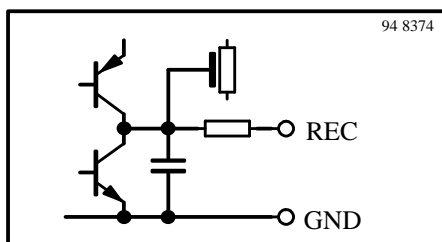

INT

Integrator output: The voltage V_{INT} is the control voltage for the AGC. The capacitor C2 between INT and DEC defines the time constant of the integrator. The current through the capacitor is the input signal of the decoder.

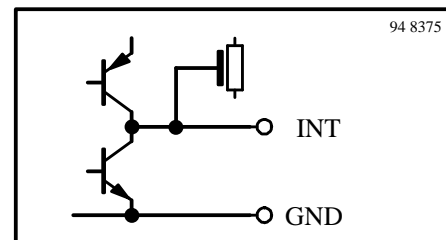

DEC

Decoder input: Senses the current through the integration capacitor C2. The dynamic input resistance has a value of about 420kΩ and is low compared to the impedance of C2.

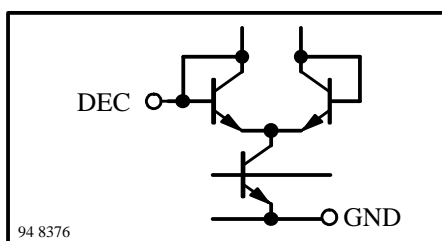

FLA, FLB

Lowpass filter: A capacitor C3 connected between FLA and FLB suppresses higher frequencies at the trigger circuit of the decoder.

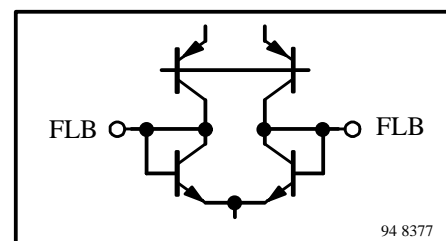

Q2A, Q2B

According to Q1A, Q1B a crystal is connected between the pins Q2A and Q2B. It is used with the serial resonance frequency of the time code transmitter (e.g. 60 kHz WWVB, 77.5 kHz DCF or 40 kHz JG2AS). The equivalent parallel capacitor of the filter crystal is internally compensated. The value of the compensation is about 0.7 pF.

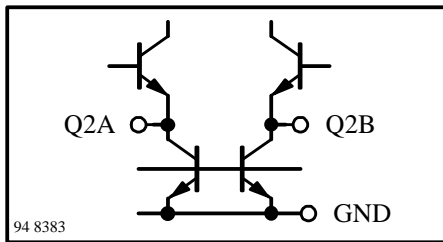

PON

If PON is connected to GND, the U 4224 B receiver IC will be activated. The set-up time is typical 0.5s after applying GND at this pin. If PON is connected to V_{CC}, the receiver will go into power down mode.

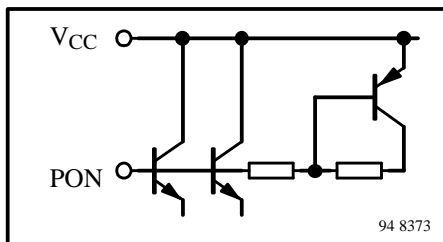

TCO

The digitized serial signal of the time code transmitter can be directly decoded by a microcomputer. Details about the time code format of several transmitters are described separately.

The output consists of a PNP – NPN push-pull-stage. It should be taken into account that in the power down mode (PON = high) TCO will be high.

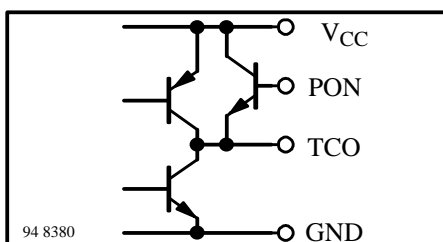

An additional improvement of the driving capability may be achieved by using a CMOS driver circuit or a NPN transistor with pull-up resistor connected to the collector (see figure KEIN MERKER). Using a CMOS driver this circuit must be connected to V_{CC}.

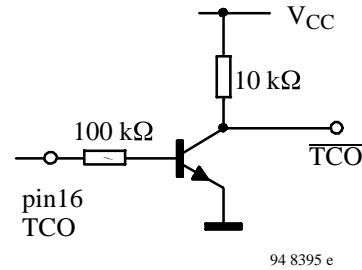

Figure 1.

Please note:

The signals and voltages at the pins REC, INT, FLA, FLB, Q1A, Q1B, Q2A and Q2B cannot be measured by standard measurement equipment due to very high internal impedances. For the same reason the PCB should be protected against surface humidity.

Design Hints for the Ferrite Antenna

The bar antenna is a very critical device of the complete clock receiver. But by observing some basic RF design knowledge, no problem should arise with this part. The IC requires a resonance resistance of 50 kΩ to 200 kΩ. This can be achieved by a variation of the L/C-relation in the antenna circuit. But it is not easy to measure such high resistances in the RF region. It is much more convenient to distinguish the bandwidth of the antenna circuit and afterwards to calculate the resonance resistance.

Thus the first step in designing the antenna circuit is to measure the bandwidth. Figure 4 shows an example for the test circuit. The RF signal is coupled into the bar antenna by inductive means, e.g. a wire loop. It can be measured by a simple oscilloscope using the 10:1 probe. The input capacitance of the probe, typically about 10 pF, should be taken into consideration. By varying the frequency of the signal generator, the resonance frequency can be determined.

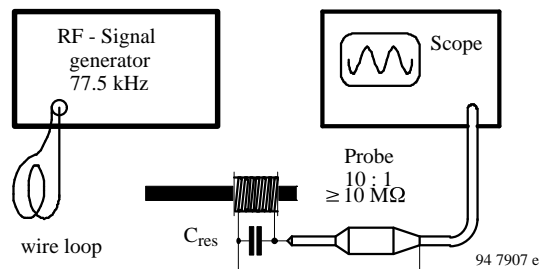

Afterwards, the two frequencies where the voltage of the rf signal at the probe drops 3 dB down can be measured. The difference between these two frequencies is called the bandwidth BW_A of the antenna circuit. As the value of the capacitor C_{res} in the antenna circuit is well known, it is easy to compute the resonance resistance according to the following formula:

$$R_{res} = \frac{1}{2 \cdot \pi \cdot BW_A \cdot C_{res}}$$

whereas

R_{res} is the resonance resistance,

BW_A is the measured bandwidth (in Hz)

C_{res} is the value of the capacitor in the antenna circuit (in Farad)

If high inductance values and low capacitor values are used, the additional parasitic capacitances of the coil must be considered. It may reach up to about 20 pF. The Q-value of the capacitor should be no problem if a high Q-type is used. The Q-value of the coil is more or less distinguished by the simple DC-resistance of the wire. Skin effects can be observed but do not dominate.

Therefore it shouldn't be a problem to achieve the recommended values of resonance resistance. The use of thicker wire increases Q and accordingly reduces bandwidth. This is advantageous in order to improve reception in noisy areas. On the other hand, temperature compensation of the resonance frequency might become a

problem if the bandwidth of the antenna circuit is low compared to the temperature variation of the resonance frequency. Of course, Q can also be reduced by a parallel resistor.

Temperature compensation of the resonance frequency is a must if the clock is used at different temperatures. Please ask your dealer of bar antenna material and of capacitors for specified values of temperature coefficient.

Furthermore some critical parasitics have to be considered. These are shortened loops (e.g. in the ground line of the PCB board) close to the antenna and undesired loops in the antenna circuit. Shortened loops decrease Q of the circuit. They have the same effect like conducting plates close to the antenna. To avoid undesired loops in the antenna circuit it is recommended to mount the capacitor C_{res} as close as possible to the antenna coil or to use a twisted wire for the antenna coil connection. This twisted line is also necessary to reduce feedback of noise from the microprocessor to the IC input. Long connection lines must be shielded.

A final adjustment of the time code receiver can be done by pushing the coil along the bar antenna. The maximum of the integrator output voltage V_{INT} at pin INT indicates the resonant point. But attention: The load current should not exceed 1 nA, that means an input resistance $\geq 1 \text{ G}\Omega$ of the measuring device is required. Therefore a special DVM or an isolation amplifier is necessary.

Absolute Maximum Ratings

Parameters	Symbol	Value	Unit
Supply voltage	V_{CC}	5.25	V
Ambient temperature range	T_{amb}	-25 to +75	°C
Storage temperature range	R_{stg}	-40 to +85	°C
Junction temperature	T_j	125	°C
Electrostatic handling (MIL Standard 883 D), excepted pins 5, 6, 13 and 14	$\pm V_{ESD}$	2000	V

Thermal Resistance

Parameters	Symbol	Value	Unit
Thermal resistance	R_{thJA}	70	K/W

Electrical Characteristics

$V_{CC} = 3\text{ V}$, reference point pin 3, input signal frequency 80 kHz, $T_{amb} = 25\text{ }^{\circ}\text{C}$, unless otherwise specified

Parameters	Test Conditions / Pin	Symbol	Min.	Typ.	Max.	Unit
Supply voltage range	pin 1	V_{CC}	1.2		5.25	V
Supply current	pin 1 without reception signal with reception signal = 200 μV OFF-mode	I_{CC}		15	30 25 0.1	μA μA μA
Set-up time after V_{CC} ON	$V_{CC} = 1.5\text{ V}$	t		2		s
AGC AMPLIFIER INPUT; IN pin 2						
Reception frequency range		f_{in}	40		80	kHz
Minimum input voltage	$R_{res} = 100\text{ k}\Omega$, $Q_{res} > 30$	V_{in}		1	1.5	μV
Maximum input voltage		V_{in}	40	80		mV
Input capacitance to ground		C_{in}		1.5		pF
TIMING CODE OUTPUT; TCO pin 16						
Output voltage HIGH LOW	$R_{LOAD} = 870\text{ k}\Omega$ to GND $R_{LOAD} = 650\text{ k}\Omega$ to V_{CC}	V_{OH} V_{OL}	$V_{CC}-0.4$		0.4	V V
Output current HIGH LOW	$V_{TCO} = V_{CC}/2$ $V_{TCO} = V_{CC}/2$	I_{SOURCE} I_{SINK}	3 4	10 12		μA μA
Decoding characteristics	DCF77 based on the values of the application circuit page KEIN MERKER: TCO pulse width 100 ms TCO pulse width 200 ms Delay compared with the transient of the RF signal: drop down (start transition) rise for 100 ms pulse (end transition) rise for 200 ms pulse (end transition)	t_{100} t_{200} t_s t_{e1} t_{e2}	60 160 30 25 10	90 190 60 55 30	130 230 60 55 30	ms ms ms ms ms
Decoding characteristics	WWVB based on the values of the application circuit page KEIN MERKER: TCO pulse width 200 ms TCO pulse width 500 ms TCO pulse width 800 ms Delay compared with the transient of the RF signal: drop down (start transition) rise (end transition)	t_{200} t_{500} t_{800} t_s t_e	140 440 740 45 20		200 500 800 80 45	ms ms ms ms ms

Parameters	Test Conditions / Pin	Symbol	Min.	Typ.	Max.	Unit
Decoding characteristics	JG2AS based on the values of the application circuit page KEIN MERKER: TCO pulse width 200 ms TCO pulse width 500 ms TCO pulse width 800 ms	t_{200}	240		410	ms
		t_{500}	420		490	ms
		t_{800}	720		790	ms
	Delay compared with the transient of the RF signal:					
	start transition (RF on) end transition (RF off)	t_s t_e	10 30		110 220	ms ms
POWER ON/OFF CONTROL; PON pin 15						
Input voltage HIGH LOW	Required $I_{IN} \geq 0.5 \mu A$		$V_{CC}-0.2$		$V_{CC}-1.2$	V V
Input current	$V_{CC} = 3V$ $V_{CC} = 1.5 V$ $V_{CC} = 5 V$	I_{IN}	1.4	1.7 0.7 3	2	μA μA μA
Set-up time after PON		t		0.5	2	s
AGC HOLD MODE; SL pin 12						
Input voltage HIGH LOW	Required $I_{IN} \geq 0.5 \mu A$		$V_{CC}-0.2$		$V_{CC}-1.2$	V V
Input current	$V_{in} = V_{CC}$ $V_{in} = GND$			2.5	0.1	μA μA
Rejection of interference signals	$ f_d - f_{ud} = 625 \text{ Hz}$ $V_d = 3 \mu V$, $f_d = 77.5 \text{ kHz}$ using 2 crystal filters using 1 crystal filter	a_f		43		dB
		a_f		22		dB

Application Circuit for JG2AS 40 kHz

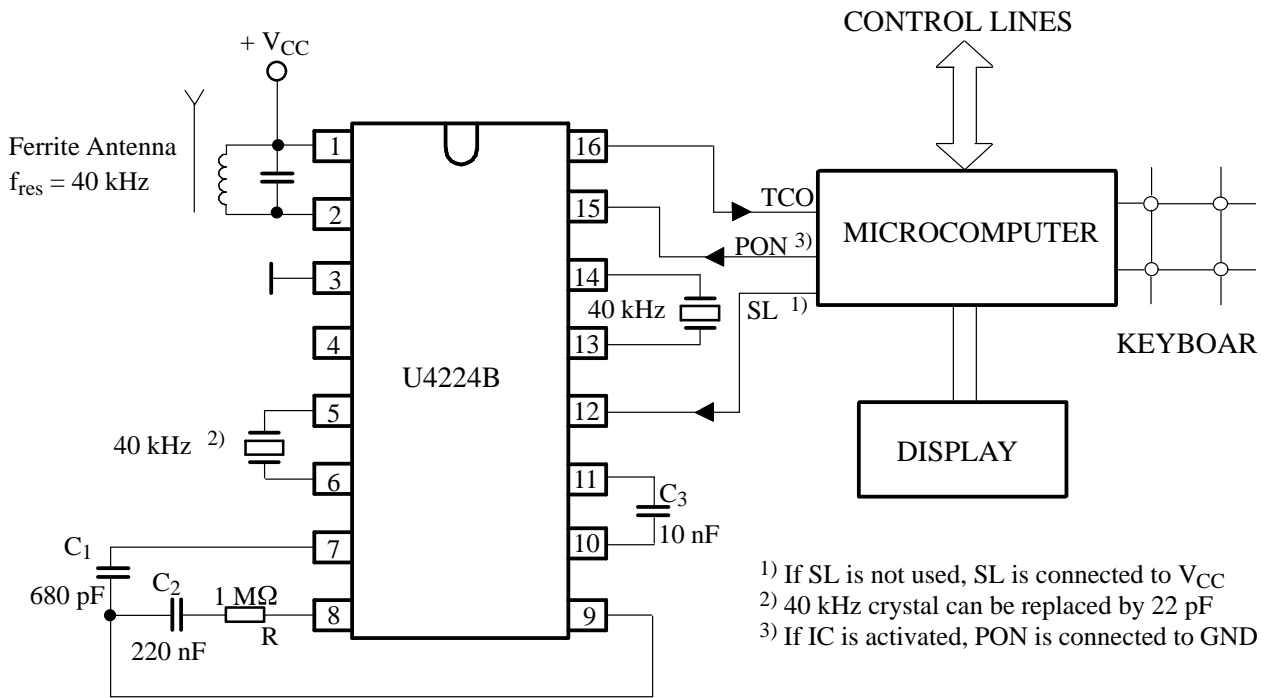

94 7724 e

PAD Coordinates

The T4224B is the die version of the U4224B.

DIE size: 2.26 x 2.09 mm
 PAD size: 100 x 100 μm (contact window 88 x 88 μm)
 Thickness: 300 $\mu\text{m} \pm 20 \mu\text{m}$

Symbol	x-axis/ μm	y-axis/ μm
IN1	128	758
IN	128	310
GND	354	124
SB	698	128
Q1A	1040	128
Q1B	1290	128
REC	1528	128
INT	1766	128
DEC	2044	268

Symbol	x-axis/ μm	y-axis/ μm
FLA	2044	676
FLB	2044	1012
SL	2044	1624
Q2A	1980	1876
Q2B	1634	1876
PON	1322	1876
TCO	1008	1876
VCC	128	1098

The PAD coordinates are referred to the left bottom point of the contact window.

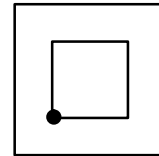

PAD Layout

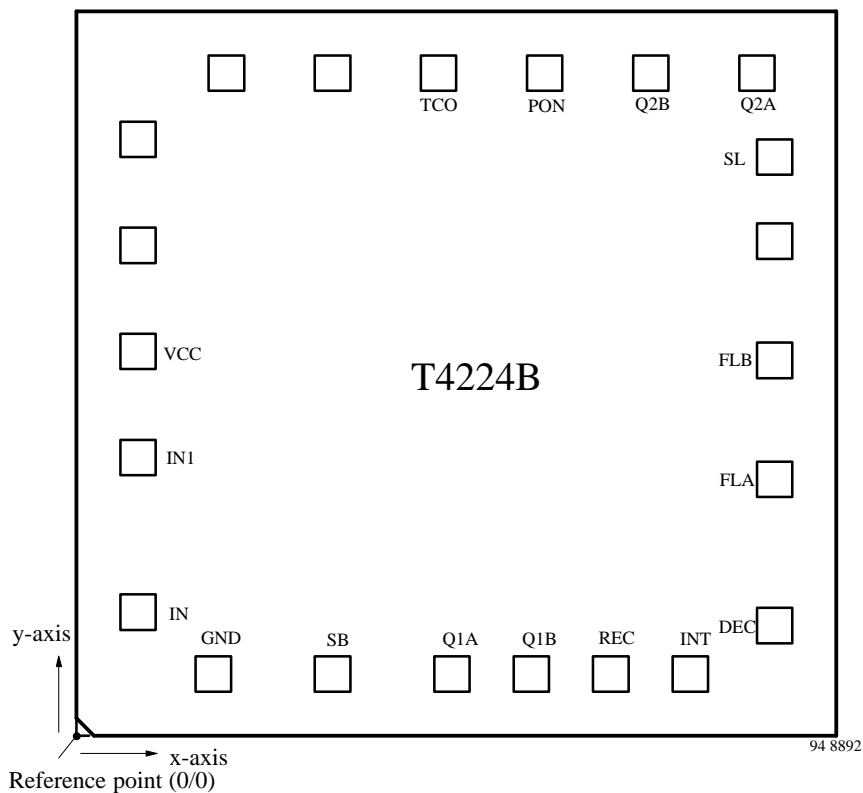

Information Regarding German Transmitter

Station: DCF 77,
 Frequency 77.5 kHz,
 Transmitting power 50 kW

Location: Mainflingen/Germany,
 Geographical coordinates: 50° 01'N, 09° 00'E
 Time of transmission: permanent

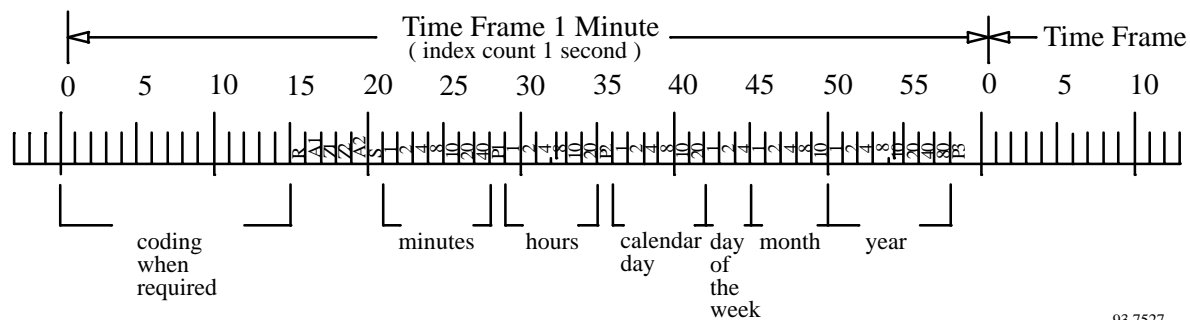

93 7527

Example: 19.35 h

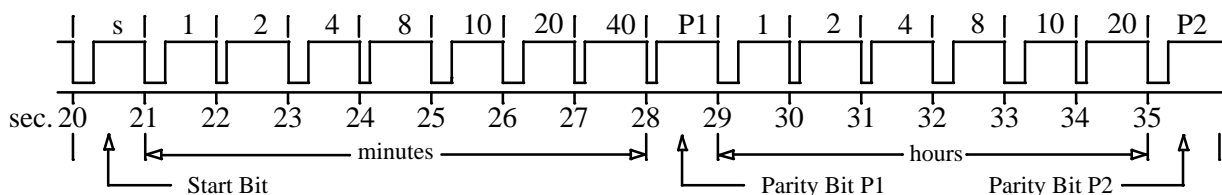

Modulation:

The carrier amplitude is reduced to 25 % at the beginning of each second for 100 ms (binary zero) or 200 ms (binary one) duration, excepting the 59th second.

Time Code Format: (based on information of Deutsche Bundespost)

It consists of 1 minute time frames. No modulation at the

beginning of the 59th second to recognize the switch over to the next 1 minute time frame. A time frame contains BCD-coded information of minutes, hours, calendar day, day of the week, month and year between the 20th second and 58th second of the time frame, including the start bit S (200 ms) and parity bits P1, P2 and P3. Further there are 5 additional bits R (transmission by reserve antenna), A1 (announcement of change-over to the summer time), Z1 (during the summer time 200 ms, otherwise 100 ms), Z2 (during standard time 200 ms otherwise 100 ms) and A2 (announcement of leap second) transmitted between the 15th second and 19th second of the time frame.

Information Regarding British Transmitter

Station: MSF
 Frequency 60 kHz
 Transmitting power 50 kW
 Location: Teddington, Middlesex

Geographical coordinates: 52° 22'N, 01° 11'W
 Time of transmission: permanent, excepting the first tuesday of each month from 10.00 h to 14.00 h.

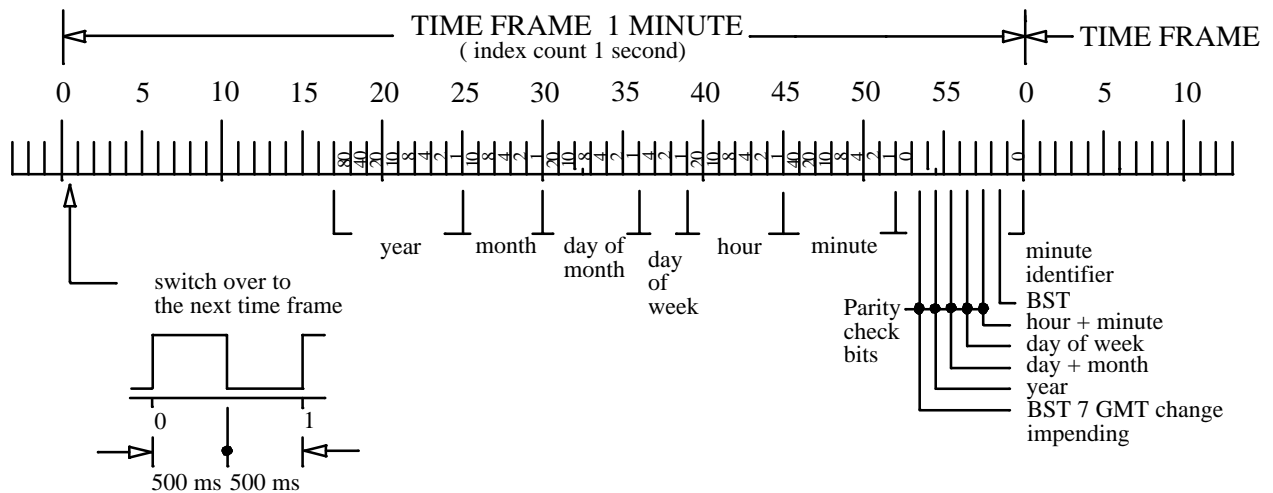

93 7528

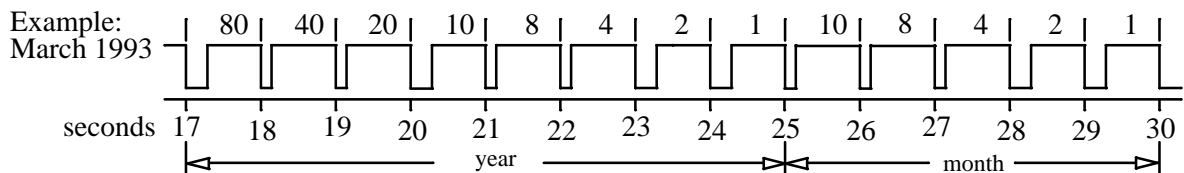

Modulation:

The carrier amplitude is switched off at the beginning of each second for the time of 100 ms (binary zero) or 200 ms (binary one).

Time Code Format:

It consists of 1 minute time frames. A time frame contains BCD-coded information of year, month, calendar day, day of the week, hours and minutes. At the switch-over to the next time frame, the carrier amplitude is reduced for 500 ms duration.

The presence of the fast code during the first 500 ms at the beginning of the minute is not guaranteed. The transmission rate is 100 bits/s and the code contains information of hour, minute, day and month.

Information Regarding US Transmitter

Station: WWVB
 Frequency 60 kHz
 Transmitting power 10 kW

Location: Fort Collins
 Geographical coordinates: 40° 40'N, 105° 03'W
 Time of transmission: permanent.

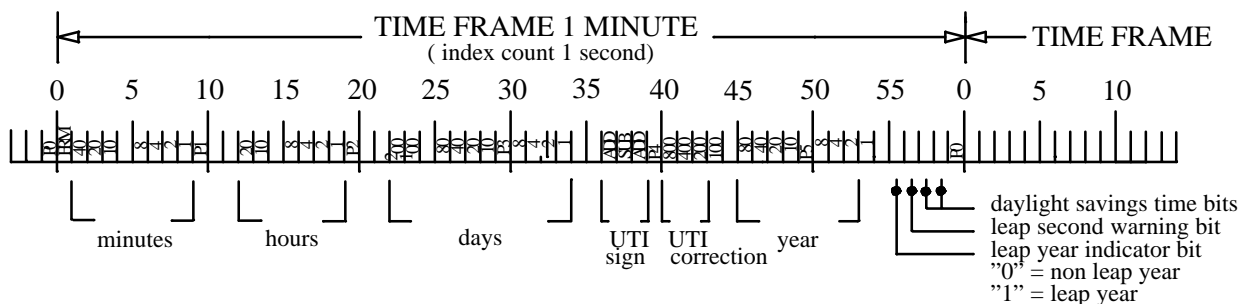

93 7529 e

Example: UTC 18.42 h

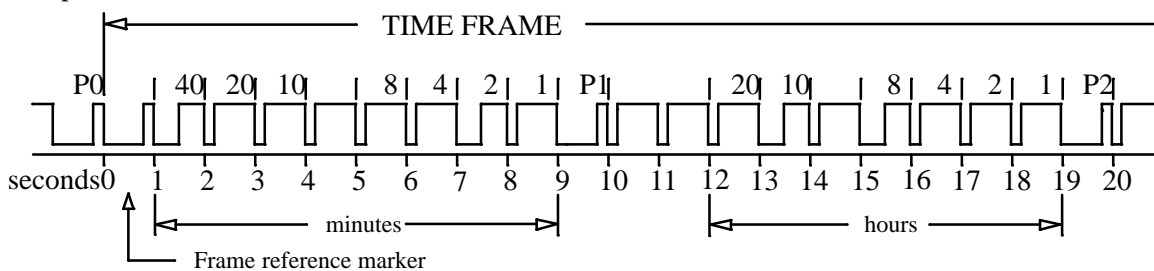

Modulation:

The carrier amplitude is reduced 10 dB at the beginning of each second and is restored in 500 ms (binary one) or in 200 ms (binary zero).

Time Code Format:

It consists of 1 minute time frames. A time frame contains BCD-coded information of minutes, hours, days and year. In addition there are 6 position identifier markers (P0 thru P5) and 1 frame reference marker with reduced carrier amplitude of 800 ms duration.

Information Regarding Japanese Transmitter

Station: JG2AS
Frequency 40 kHz
Transmitting power 10 kW

Location: Sanwa, Ibaraki
Geographical coordinates: 36° 11' N, 139° 51' E
Time of transmission: permanent

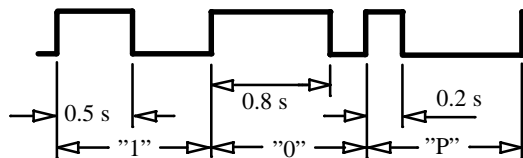
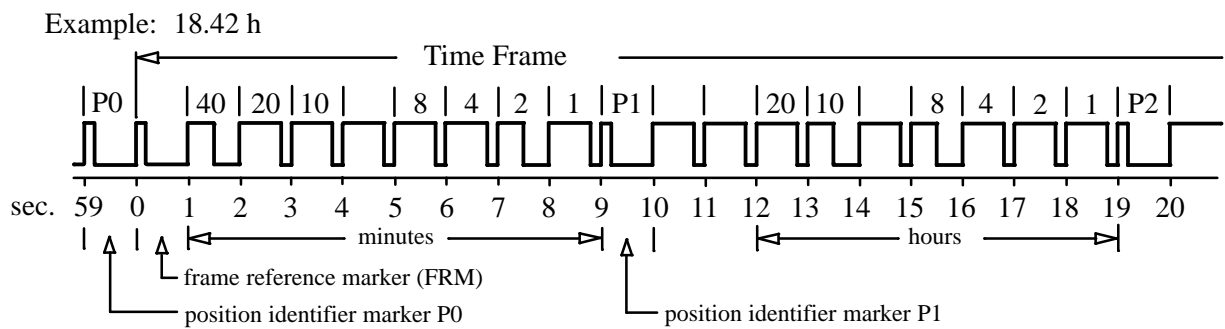
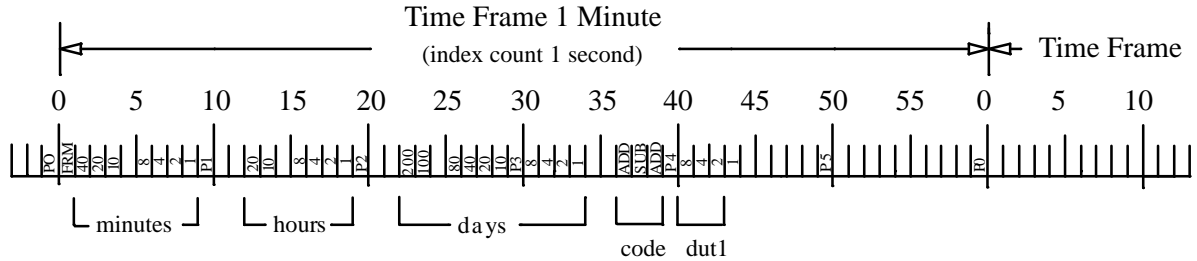

0.5 second: Binary one
0.8 second: Binary zero
0.2 second: Identifier markers P0...P5

93 7508 e

Modulation:

The carrier amplitude is 100% at the beginning of each second and is switched off after 500 ms (binary one) or after 800 ms (binary zero).

Time Code Format:

It consists of one minute time frame. A time frame contains BCD-coded information of minutes, hours and days. In addition there are 6 position identifier markers (P0 thru P5) and one frame reference markers (FRM) with reduced carrier amplitude of 800 ms duration.

Ordering and Package Information

Extended type number	Package	Remarks
U4224B-CFL	SO 16 L plastic	
U4224B-CFLG3	SO 16 L plastic	Taping according to IEC-286-3
T4224B-CF	no	die on foil
T4224B-CC	no	die on tray

Dimensions in mm

Package: SO 16 L

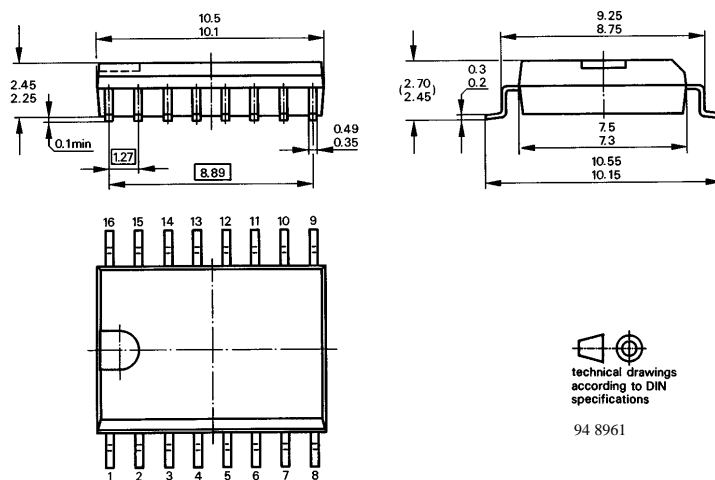

technical drawings
according to DIN
specifications

94 8961

Ozone Depleting Substances Policy Statement

It is the policy of **TEMIC TELEFUNKEN microelectronic GmbH** to

1. Meet all present and future national and international statutory requirements.
2. Regularly and continuously improve the performance of our products, processes, distribution and operating systems with respect to their impact on the health and safety of our employees and the public, as well as their impact on the environment.

It is particular concern to control or eliminate releases of those substances into the atmosphere which are known as ozone depleting substances (ODSs).

The Montreal Protocol (1987) and its London Amendments (1990) intend to severely restrict the use of ODSs and forbid their use within the next ten years. Various national and international initiatives are pressing for an earlier ban on these substances.

TEMIC TELEFUNKEN microelectronic GmbH semiconductor division has been able to use its policy of continuous improvements to eliminate the use of ODSs listed in the following documents.

1. Annex A, B and list of transitional substances of the Montreal Protocol and the London Amendments respectively
2. Class I and II ozone depleting substances in the Clean Air Act Amendments of 1990 by the Environmental Protection Agency (EPA) in the USA
3. Council Decision 88/540/EEC and 91/690/EEC Annex A, B and C (transitional substances) respectively.

TEMIC can certify that our semiconductors are not manufactured with ozone depleting substances and do not contain such substances.

We reserve the right to make changes to improve technical design and may do so without further notice.

Parameters can vary in different applications. All operating parameters must be validated for each customer application by the customer. Should the buyer use TEMIC products for any unintended or unauthorized application, the buyer shall indemnify TEMIC against all claims, costs, damages, and expenses, arising out of, directly or indirectly, any claim of personal damage, injury or death associated with such unintended or unauthorized use.

TEMIC TELEFUNKEN microelectronic GmbH, P.O.B. 3535, D-74025 Heilbronn, Germany
Telephone: 49 (0)7131 67 2831, Fax number: 49 (0)7131 67 2423